



**What if you tried a new,
sustainable approach?**





VESTA®

Bio-based technology covered by 10 patents

VESTA® (Vegetal Ecological Stable Timber Advantage)

Our technology combines a very high wood fibre content, natural mineral salts and pigments and a neutral thermal binder free from heavy metals or phthalates.

This ingenious combination of plants and minerals creates an eco-material with certified technical performance.



Resistance and stability

The VESTA® is naturally rot-proof and hydrophobic for perfect resistance to bad weather, insects and fungi. Its impressive dimensional stability avoids any risk of deformation.



Shades and colours that stand the test of time

Mass-dyed using mineral pigments, VESTA® doesn't grey. After a few weeks of uniform weathering, the colour stabilises and no longer changes over time, guaranteeing a long-lasting and harmonious look for your work.



Quick installation

Our solutions' installation system has been specially designed for quick and easy set-up.



No maintenance required

Once installed, our materials don't require any maintenance: no need for cleaning or later chemical treatments (varnish, staining, insecticide).



Bio-sourced label

Our eco-material VESTA® our products have been certified as a "bio-sourced product" by Karibati, an independent organisation expert in bio-sourced materials. Accreditation No. 14/06/21/38.



100% recyclable

The materials used in VESTA® are 100% recyclable. They can be ground down again and reused to manufacture new equally high-performance equivalent products.



Our colour chart

Natural shades that withstand the test of time

Our eco-material VESTA® primarily consists of natural components: wood fibres, salts and mineral pigments.

Our VESTA® profiles and boards **inherently feature colour nuances**, such as terracotta, ceramic, slate or wood, which adds the aesthetic charm and singularity of natural products.

Once installed, our products being a weathering process associated with their bio-sourced material composition. These changes to the product are entirely normal and may continue over several months. Using mineral pigments, which present high UV stability, **guarantee long-lasting colours**, with shades and nuances that continue between boards or profiles according to multiple factors:

- Depending on the exposure of the various façades of a given project (ultraviolet rays, weather, etc.) and architectural specificities;
- The alternating of different Neolife profiles which, according to their specific geometry, won't catch light in the same way or which aren't from the same production run (notion of washing, as is the case with mineral façades);
- Depending on the direction of laying and/or the field of application chosen for the project (horizontal installation, vertical installation, screening, underside, etc.);
- According to the installation schedule on the work site, with product installation staggered over multiple weeks or even months for a given façade.



To guarantee a long-lasting visual result and to allow for the cladding to be naturally washed by the rain, we recommend using a vertical laying direction, particularly for lighter colours (Moon, Sand, Sun and Ocean).

The RAL references shown are for illustrative purposes only and do not constitute a guarantee of the shade naturally obtained on the installation. These RALs are based on the measurements taken in the factory using the samples collected: raw samples and weathered samples in our ageing area.

Our ranges



Cladding

Pages 6 to 19



Mouldings

Pages 10 to 11

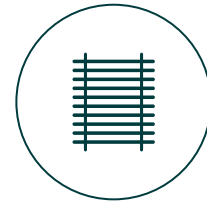

Decorative profiles

Pages 20 to 23

Technical solutions

Our expertise and quality standards guarantee the technical performance of our products.

With CSTB Agrément Certification, our cladding is designed to meet the requirements of current constructions, in line with RE2020 and the 2025 carbon thresholds.

For any type of project

Both in new builds or redevelopments, our solutions adapt to a number of projects.

Our ranges are also ideal for off-site construction.

Exceptional creative freedom with multiple options for finishes and layouts:

- Wide choice of shades and waves
- Horizontal or vertical installation with CSTB Agrément Certification
- Can be installed on curved walls
- Combination with mouldings and accessories



Public buildings



Non-residential buildings



Multi-unit housing



Single-family housing



So that we can adapt our ranges to the issues and realities of your projects, we offer our cladding in 5 standard sizes.

More flexibility and a high-quality service to allow you to order quantities that best suit your needs, meaning that:

- refine and reduce costs
- optimise waste
- consume only what is strictly necessary

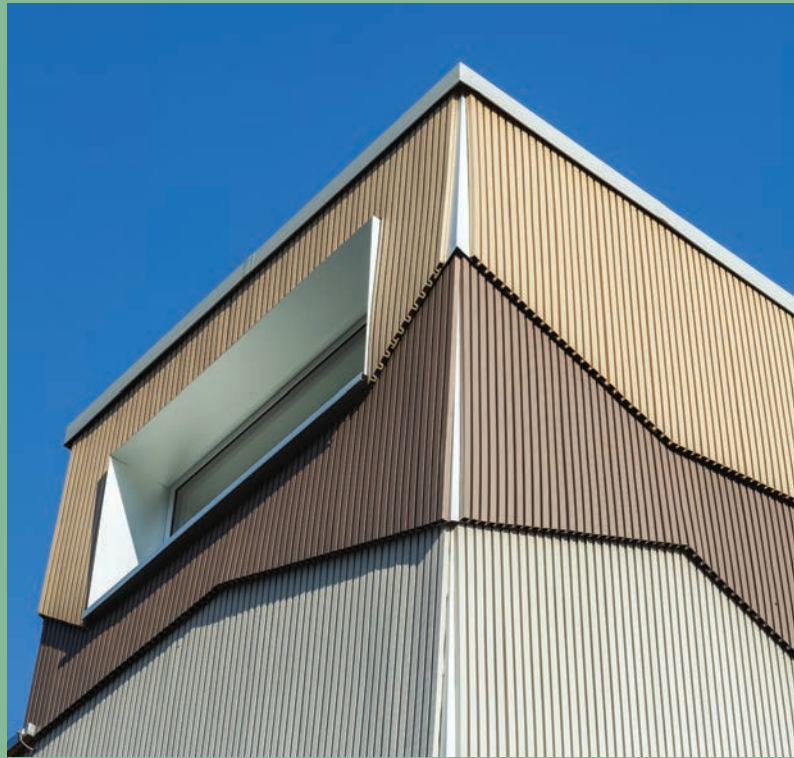

© Photo credit: Didier Jordan

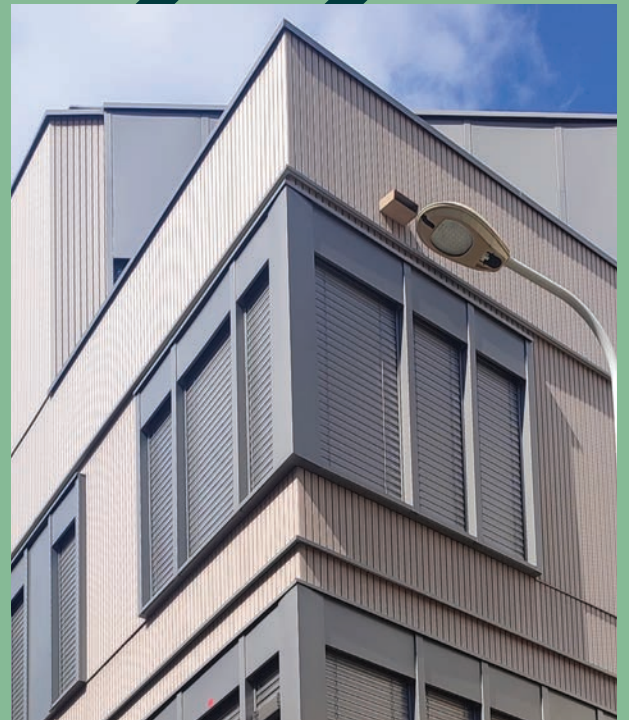

Discover our decorative profiles and cladding at:

bimobject[®]





COVER cladding

Bold architecture with an unprecedented fire rating!



Installation locations

- Category 1, 2 and 3 family housing units A and B (IT 249)
- Public building categories 1 to 5 (IT 249)
- Labour code-classified buildings

Specifications

- Made with VESTA®: A material with high wood fibre content, 100% recyclable and certified "bio-sourced"
- Matt finish, elegant and contemporary aesthetic
- Natural and long-lasting colours (→ colour chart p3)
- Maintenance free, rot-proof and hydrophobic
- Four profiles that can be seamlessly combined with waves of 6, 14 and 30 cm
- Invisible fixings using stainless steel screws and hooks
- Compatible mouldings: FINEO, FUSEO, LINEO



The COVER range

	COVER FLEXO	COVER 6	COVER 14	COVER 30
Number of waves	1	4	2	1
Wave width (mm)	60	60	140	300

Standard dimensions (mm)

Length: 2000 / 2500 / 3000 / 3500 / 4000
Width: 300 (except COVER FLEXO : 75)

Overview

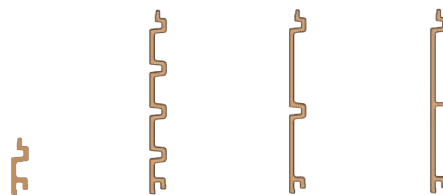

M1

Euroclass B



GWP Carbon Impact: 32 KgCO₂/m²



Wind V4



Impact Q4



Seismic: zones 1,2,3,4

For more information, please download our technical specification booklets on our website www.neolife.fr/en



COVER FLEXO

The cladding board that bends to any architectural challenge!

A single 60 mm wave that covers curved walls up to 1-metre radius. A clever addition to the COVER range.

Specifications

- Vertical installation on convex or concave curved wall up to 1 m radius
- Can be combined with the entire COVER range
- Invisible fixing using stainless steel screws and hooks on convex wall
- Discreet fixing using lacquered stainless steel screws on concave wall



Vertical installation on convex curved wall with a minimum radius of 1m



Vertical installation on concave curved wall with a minimum radius of 1m

☺☺
Ideal for installation on a curved wall with a small radius

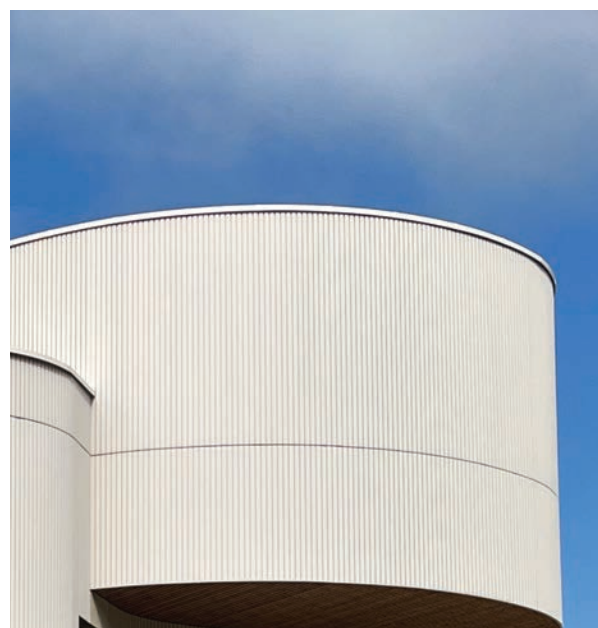

DISCOVER NOW

FUSEO, LINEO, FINEO

Clever profiles to complement our cladding ranges and open up new architectural possibilities.

→ Discover on pages 10-11



Collège Simone Veil school – Saint-Priest (69) – COVER 6 – Colour: Graphite • Architect: Lyon Metropole Region



Aquatic centre – Aubervilliers (93) – COVER 6 – Colour: Sun • Architect: Chabanne •
 © Photo credit: Jean-Charles Caslot



Les Logis de Brunet – La Ciotat (13) – COVER 6 & 14 –
 Colour: Sun • Architect: Labastie Architecture • © Photo credit:
 Thierry Lavernos – Eiffage





Maasdelta Groep Head Offices - Netherlands - COVER 6 - Colour: Sun • Architect: Groosman Architecten



Cancer treatment centre - Le Mans (72) - COVER 14 & 30 - Colour: Sand • Architect: Chabanne • © Photo credit: Erick Salliet



Collège Louise Michel school - Bourneville (27) - COVER 6 - Colour: Sun • Architect: ACAU & AP-MA • © Photo credit: Initial Ingénierie - Matthieu Lecouvey



Mouldings

Smart profiles that complement our cladding ranges and open up new architectural possibilities.

Specifications

- Made with VESTA®: A material with high wood fibre content, 100% recyclable and certified “bio-sourced”
- Natural and long-lasting colours (→ colour chart p3)
- Quick and easy implementation by interlocking in the cladding boards
- Installation on masonry wall, wood or metal framework
- Vertical or horizontal installation



FINEO

Its M-shape handles internal and external angles for a perfect and a finish that matches the cladding.

Can be combined with all our cladding.



FINEO on an external angle



FINEO on an internal angle

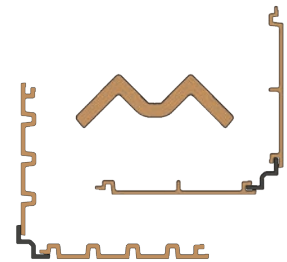

FUSEO

Junction profile to merge two boards and create a smooth effect by making the hollow of the wave disappear.

Can only be combined with the COVER range.

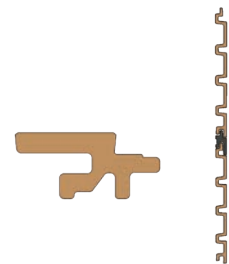
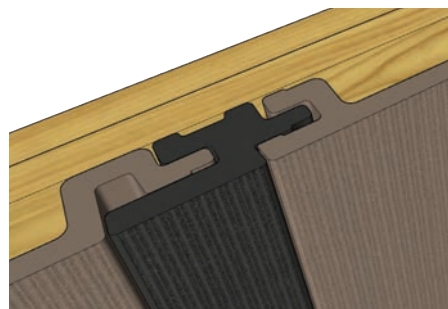

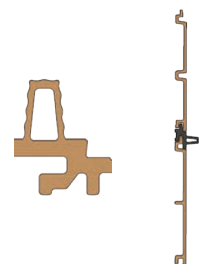
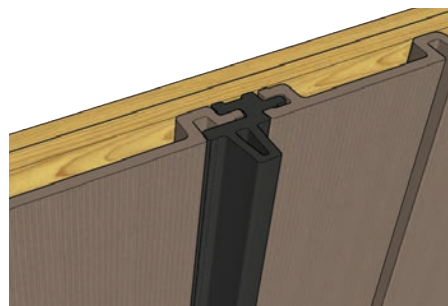

LINEO

Used to enhance the façade with prominent lines and therefore create different undulations between the waves. **Can only be combined with the COVER range.**

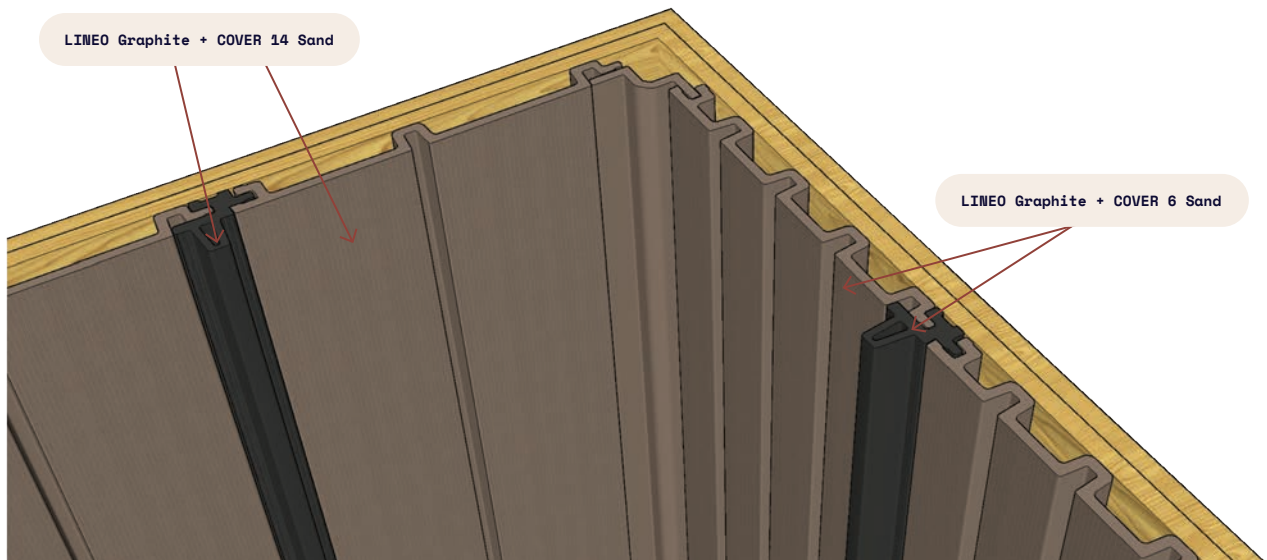
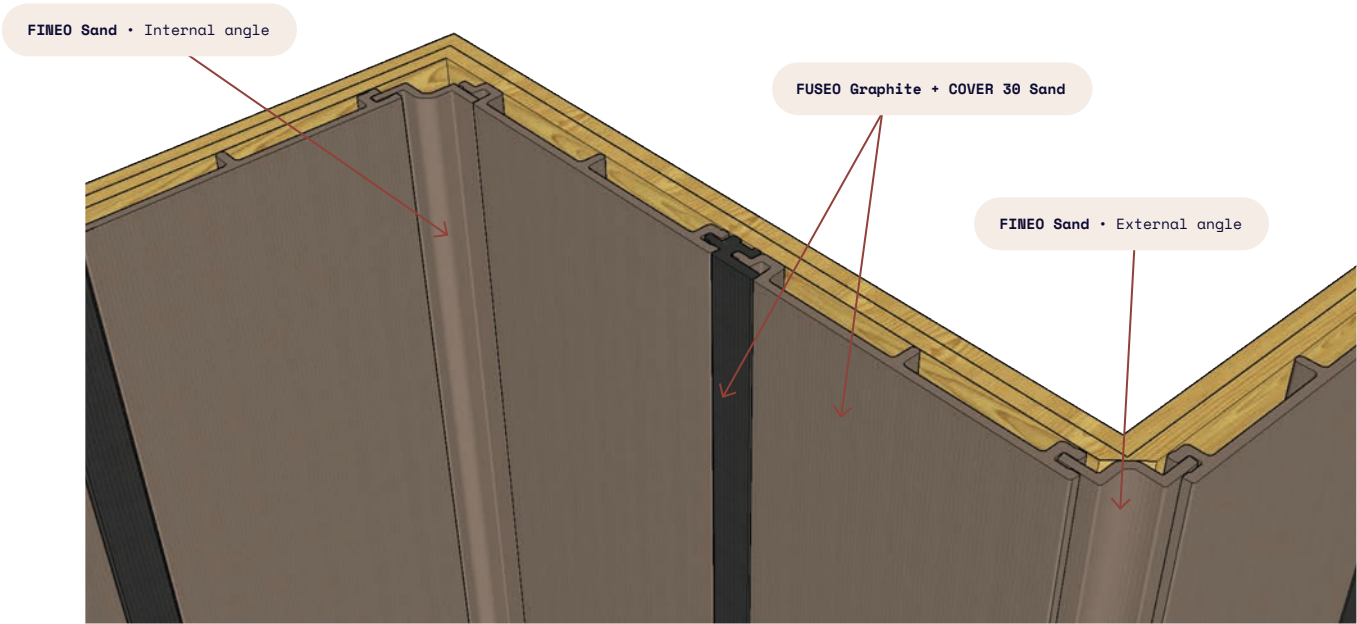



The moulding range

	FINEO	LINEO	FUSEO
Profile length (mm)	3000 (other dimensions available on request)		
Interlocked profile width (mm)	60	44	44
Total thickness (mm)	29,4	58,5	28,5
Profile weight	1,30 kg/ml	1,60 kg/ml	1,15 kg/ml
Compatible with	All Neolife cladding	COVER	COVER
Overview			



LINK cladding

**IDEAL FOR TIMBER
FRAME FACADES**

Optimised and cleverly designed boards, suitable for timber frame façades.



Specifications



- Made with VESTA®: A material with high wood fibre content, 100% recyclable and certified "bio-sourced"
- Matt finish, elegant and contemporary aesthetic
- Natural and long-lasting colours (→ colour chart p3)
- Maintenance free, rot-proof and hydrophobic
- Three profiles that can be seamlessly combined with waves of 6, 14 and 20 cm
- Particularly well-suited to timber frame constructions and timber frame facades
- Concealed fixing with lacquered stainless steel screws
- Compatible mouldings: FINEO

Installation locations

- Housing category 1, 2 and 3 family units A and B (IT 249)
- Public building categories 1 to 5 (IT 249)
- Labour code-classified buildings
- Compatible with DTU 31.4 on timber frame façades (validation pending)



The LINK range

	LINK 6	LINK 14	LINK 20 NEW
Number of waves	4	2	1
Wave width (mm)	60	140	200
Standard dimensions (mm)	Length: 2000 / 2500 / 3000 / 3500 / 4000 Width: 300 (except LINK 20 : 200)		
Overview			



M1

Euroclass B



GWP Carbon Impact :
27 KgCO₂/m²



Wind V4



Impact Q4



Seismic:
zones 1,2,3,4

* LINK 6 and 14: Agrément Certificate for concrete and metal supports. On wood, file submitted to the CSTB and pending review.
LINK 20: pending certification.

Fixing with screws concealed behind the interlocking

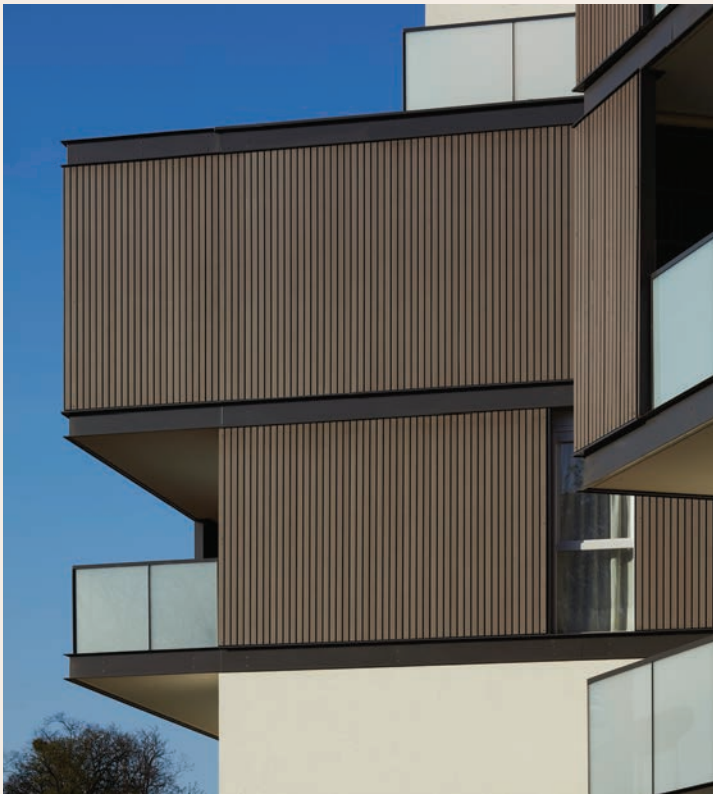
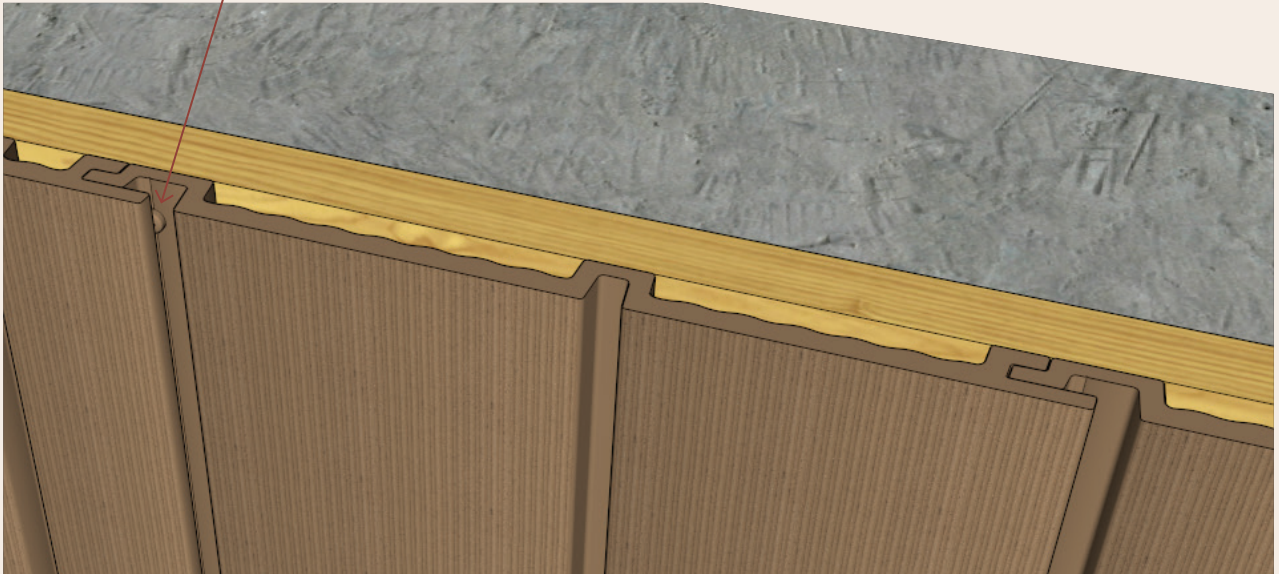

Photo non-binding



Photo non-binding

For more information, please download our technical specification booklets on our website www.neolife.fr/en





SMART cladding

A versatile and optimised range for any project dealing with moderate fire restrictions.



Installation locations

- Housing category 1 and 2 family units (G+3 max.)
- Public building category 5
- Labour code-classified buildings

Specifications

- Made with VESTA®: A material with high wood fibre content, 100% recyclable and certified "bio-sourced"
- Matt finish, elegant and contemporary aesthetic
- Natural and long-lasting colours (→ colour chart p3)
- Maintenance free, rot-proof and hydrophobic
- Two profiles that can be combined with 4 or 9 cm waves
- Discreet fixing with lacquered stainless steel screws
- Compatible mouldings: FINEO



© Photo credit: Simon Guesdon

The SMART range

	SMART 4	SMART 9
Number of waves	6	3
Wave width (mm)	40	90
Standard dimensions (mm)	Length: 2000 / 2500 / 3000 / 3500 / 4000 Width: 300	

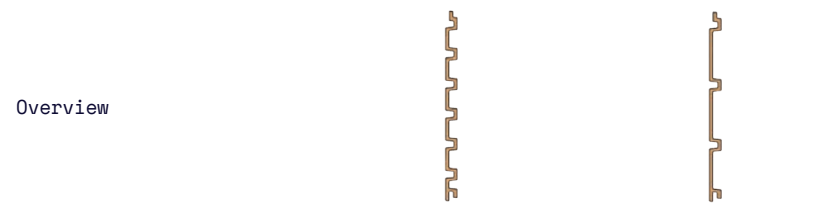

M2

Euroclass C



GWP Carbon Impact: 21 KgCO₂/m²



Wind V4



Impact Q4



Seismic: zones 1,2,3,4

For more information, please download our technical specification booklets on our website www.neolife.fr/en





Maison du Cirque - Bourg-en-Bresse (01) - SMART 9 - Colour: Graphite • Architect: Moon Safari • © Photo credit: Jean-Baptiste Rebeyrotte



MFR - Moirans (38) - SMART 4 & 9 - Colours: Sun, Sand & Earth • Architect : Dedale



Résidence Garden Square - Vitry (35) - SMART 4 - Colour: Earth • Architect: Chouzenoux Architecture • © Photo credit: Simon Guesdon





NOMAD cladding

NEW

Lightweight boards that can be combined to alternate rhythms for façades.



Installation locations

- Housing category 1 and 2 family units (G+3 max.)
- Public building category 5 (group 2)
- Labour code classified buildings

Specifications

- Made with VESTA®: A material with high wood fibre content, 100% recyclable and certified "bio-sourced"
- Matt finish, elegant and contemporary aesthetic
- Natural and long-lasting colours (→ colour chart p3)
- Maintenance free, rot-proof and hydrophobic
- Three profiles that can be seamlessly combined: NOMAD 4, NOMAD 6 and NOMAD Mix
- Can be installed onto rack and pinions without visible fixings
- Can be installed onto interconnected wood or metal framework
- Compatible mouldings: FINEO



The NOMAD range

	NOMAD 4	NOMAD 6	NOMAD MIX
Number of waves	6	4	4
Width of the wave (mm)	40	60	Irregular 47/77/27/97
Dimensions (mm)	Length: 2000 / 2500 / 3000 / 3500 / 4000 Width: 300		

* On metal or wood: Agrément Certificate for NOMAD 6, pending for NOMAD 4 and Mix. Installation onto rack and pinions: pending certification.



M3

Euroclass D



GWP Carbon Impact: 14 KgCO₂/m²



Wind V4



Impact Q3



Seismic: zones 1,2,3,4

For more information, please download our technical specification booklets on our website www.neolife.fr/en



NOMAD Mix



NOMAD 4



NOMAD 6



INSTALLATION ON RACK AND PINION - Without visible fixings

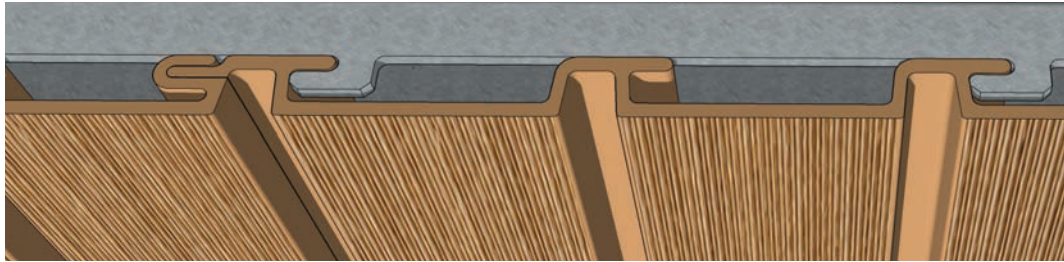

INSTALLATION ON WOOD/METAL FRAMEWORK - Interconnected fixing with lacquered screws

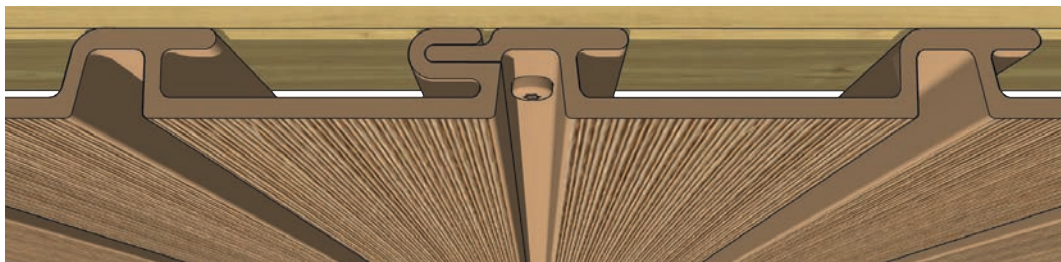

Nomad 6 - Colour: Heat



Intermarché - Binche, Belgium - Nomad 6 - Colour: Sun



CLAD cladding

A cost-efficient and aesthetic solution for structures with no fire requirements.



Installation locations

- Individual, insulated family homes - category 1
- Public building category 5
- Labour code-classified buildings

Specifications

- Made with VESTA®: A material with high wood fibre content, 100% recyclable and certified "bio-sourced"
- Matt finish, elegant and contemporary aesthetic
- Natural and long-lasting colours (→ colour chart p3)
- Maintenance free, rot-proof and hydrophobic
- A best-selling profile that never fails to impress, with narrow 4 cm waves and a depth of 2 cm
- Discreet fixing with lacquered stainless steel screws
- Compatible mouldings: FINEO



The CLAD range

	CLAD 4
Number of waves	6
Wave width (mm)	40
Standard dimensions (mm)	Length: 2000 / 2500 / 3000 / 3500 / 4000 Width: 300
Overview	



M4

Euroclass E



GWP Carbon Impact: 21 KgCO₂/m²



Wind V4



Impact Q4



Seismic: zones 1,2,3,4

For more information, please download our technical specification booklets on our website www.neolife.fr/en





STEP - Thonex, Suisse - CLAD 4 - Colours: Graphite, Earth, Heat, Sand & Sun • Architect: DZ Architectes •
 © Photo credit: Didier Jordan



EcoCity Parc - Colombes (92) - CLAD 4 - Colour: SUN • Architect: MW Architecture •
 © Photo credit: Daniel Moulinet



Pharmacie - Beaune (21) - CLAD 4 - Colour: HEAT





SPACE profiles

Whether used for decorative or shading purposes, these profiles can adapt to various uses: façade cladding, creating privacy screens, sunshades or dividing walls.



Specifications

- Made with VESTA®: A material with high wood fibre content, 100% recyclable and certified "bio-sourced"
- Natural and long-lasting colours (→ colour chart p3)
- Standard 3 metre length (other sizes on request)
- Blends in seamlessly with all our cladding solutions
- 3 fixing options: discreet fixing with stainless steel rackets / concealed fixing with stainless steel plates / Neoclin fixing
- Vertical installation on walls and between slabs
- Horizontal wall or board installation
- Can be mounted in a metal frame (not supplied by Neolife)
- Also available: cover cap

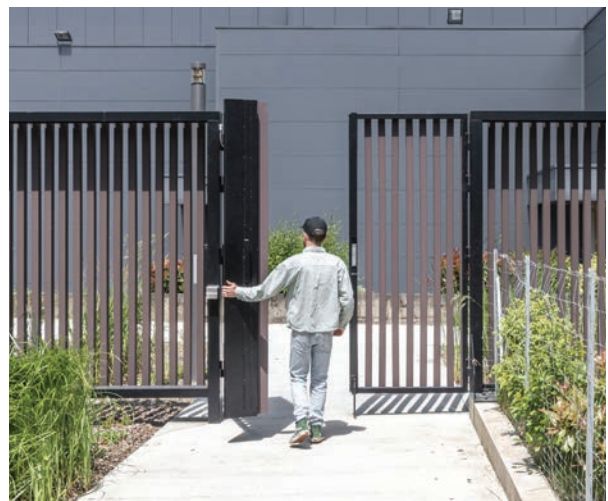

© Photo credit: Simon Guesdon

The SPACE range

	SPACE 4-6	SPACE 6-8	SPACE 6-18
Standard dimensions (mm)	3000 x 40 x 60	3000 x 60 x 80	3000 x 60 x 180
Overview			



M2

M1

on request

For more information, please download our technical specification booklets on our website www.neolife.fr/en





SPACE 6 - Colour: Sand



SPACE 4 - Colour: Sun



SPACE 4 - Colour: Earth



SPACE 6 - Colour: Sun



SHADOW profile

A hybrid profile measuring 14 cm wide, ideal for creating shutters, balcony dividers, privacy screens or sunshades.



Specifications

- Made with VESTA®: A material with high wood fibre content, 100% recyclable and certified "bio-sourced"
- Natural and long-lasting colours (→ colour chart p3)
- Standard 3 metre length (other sizes on request)
- Blends in seamlessly with all our cladding solutions
- Horizontal or vertical installation
- Can be mounted in a metal frame (not supplied by Neolife)

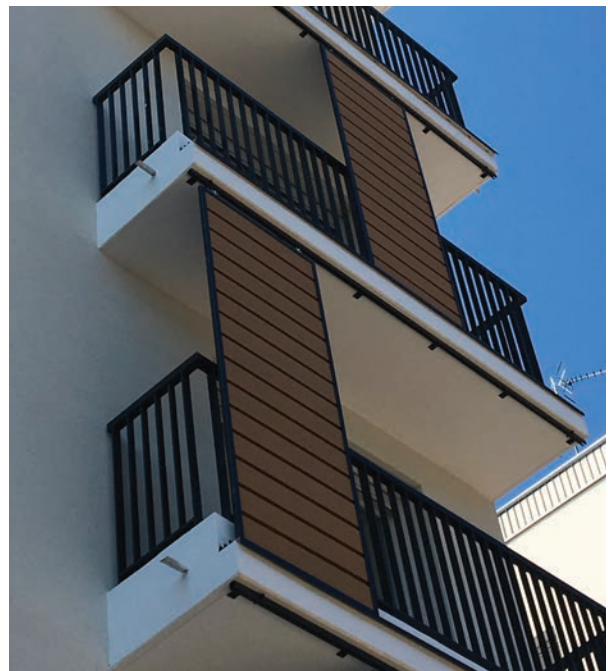

The SHADOW range

SHADOW

Standard dimensions (mm)	3000 x 140 x 20
--------------------------	-----------------



M2

M1

on request

Overview



For more information, please download our technical specification booklets on our website www.neolife.fr/en





SHADOW - Colour: Sun



SHADOW - Colour: Sun





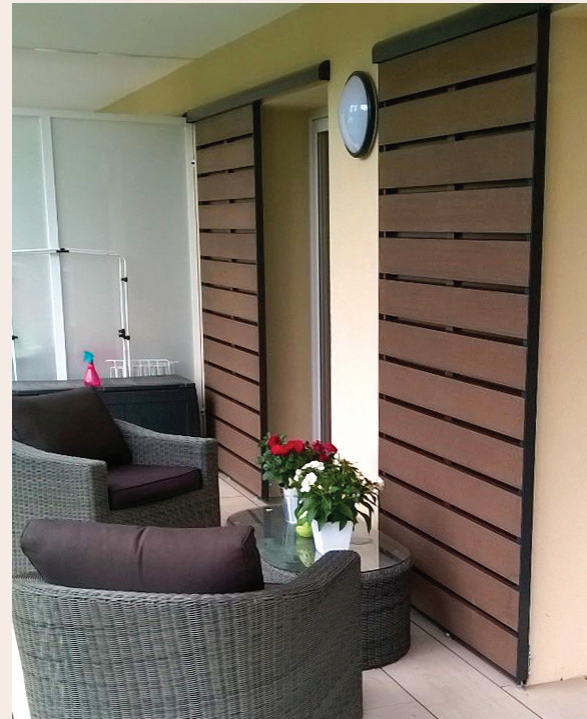



SHADOW - Colour: Sand









SHADOW - Colour: Heat

Technical specifications

Cladding boards	COVER				LINK		
	6	14	30	FLEXO	6	14	20
GWP Carbon Impact (KgCO ₂ /m ²)	32				27		
Fire rating	B-s3,d0 (M1) Complies with IT 249				B-s3,d0 (M1)		
Dimensions (mm)*	Length: 2000 / 2500 / 3000 / 3500 / 4000 Length: 300 except COVER FLEXO : 75				Length: 2000 / 2500 / 3000 / 3500 / 4000 Length: 300 except LINK 20 : 200		
Board thickness (mm)	28,5				19,5		
Weight (kg/m ²)	17,9	15,1	15,6	24,4	14,7	13,6	12,6
Application areas	<ul style="list-style-type: none"> • Category 1, 2 and 3 family housing units A and B (IT 249) • Public building categories 1 to 5 (IT 249) • Labour code-classified buildings 				<ul style="list-style-type: none"> • Category 1, 2 and 3 family housing units A and B (IT 249) • Public building categories 1 to 5 (IT 249) • Labour code-classified buildings • Compatible with DTU 31.4 on timber frame façades (validation pending) 		
Fixing type	Invisible fixing by concealed stainless steel screws and hooks				Concealed fixing with stainless steel screws		
Laying direction	Vertical / Horizontal / Underside			Vertical	Vertical / Horizontal / Underside		
Supporting walls	Concrete / Masonry of coated elements / Wood 31.2 / CLT wood / Metal sheets						
Curved wall	Faceted vertical installation with minimum radius of 3.5 m and a maximum radius of 1 m if COVER FLEXO				Faceted vertical installation, minimum radius of 3.5 m		
Profile compatibility	Combinable				Combinable		
Possible accessories	FUSEO / FINEO / LINEO				FINEO		
Profiles	6				6		
	14				14		
	30				20		
	FLEXO						



*For orders under 60m², get in touch with us

Technical specifications

Cladding boards	SMART 4	SMART 9	NOMAD 4	NOMAD 6	NOMAD MIX	CLAD 4
GWP Carbon Impact (KgCO ₂ /m ²)	21		14			21
Fire rating	C-s3,d0 (M2)		D-s3,d2 (M3)			Euroclass E (M4)
Dimensions (mm)*	Length: 2000 / 2500 / 3000 / 3500 / 4000 Width: 300					
Board thickness (mm)	19,5		17			28,5
Weight (kg/m ²)	11,7	10,7	7,9	7,7	7,3	10,6
Application areas	<ul style="list-style-type: none"> • Category 1 and 2 family housing units • Category 5 public building • Labour code-classified buildings 		<ul style="list-style-type: none"> • Category 1 and 2 family housing units • Category 5 public-access building (group 1) • Labour code-classified buildings 			<ul style="list-style-type: none"> • Insulated detached house (4 m adjoining wall) • Public building category 5 • Labour code-classified buildings
Fixing type	Discreet fixing with lacquered stainless steel screws at the bottom of waves		Discreet fixing with lacquered stainless steel screws at the bottom of the waves, installed on rack and pinion			Discreet fixing with lacquered stainless steel screws at the bottom of the waves
Laying direction	Vertical / Horizontal / Underside					
Supporting walls	Concrete / Masonry of coated elements / Wood 31.2 / CLT wood / Metal sheets					
Curved wall	Installation faceted vertical installation with a minimum radius of 3.5 m		Curved vertical installation, minimum radius of 3.5 m			Curved vertical installation, minimum radius of 3.5 m
Profile compatibility	Combinable		Combinable			/
Possible accessories	FINEO		FINEO			FINEO
Profiles	4  9 		4  6  MIX 		4 	

*For orders under 60m², get in touch with us

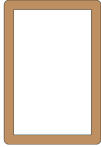
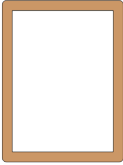
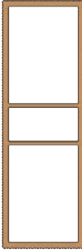
Technical specifications

Decorative profiles	SPACE 4-6	SPACE 6-8	SPACE 6-18	SHADOW
Fire rating	M2 / M1 on request			M2 / M1 on request
Dimensions (mm)*	3000 x 40 x 60	3000 x 60 x 80	3000 x 60 x 180	3000 x 140 x 20
Weight (kg/ml)	0,95	1,8	3,7	1,57
Fixing type	Discreet with stainless steel brackets / Concealed with Neoclin fixing / Invisible with stainless steel plates			Metal frame not supplied by Neolife
Laying direction	Vertical / Horizontal			
Profiles	4-6 	6-8 	6-18 	SHADOW 

*Other formats available on request

You can find all our technical documents available to download on our website www.neolife.fr/en

What if you tried a new, sustainable approach?

Innovation for a greener construction method

Neolife was founded in 2012 with a strong ethos: to design and manufacture in France a completely new eco-material, combining plants and minerals, to offer constructive solutions with low environmental impact.

Discover unique innovation: this is VESTA®, a low-carbon material with high recycled wood fibre content.

Our VESTA® range includes **cladding and other constructive solutions** designed especially for building envelopes.

Design and modularity to inspire you

We have carefully developed the colours and aesthetics of our products to deliver modern and warm designs. Plus, every year we bring you new solutions and innovative combinations for ever more architectural possibilities.

French expertise

We have chosen to manufacture in France to enhance national expertise, promote our country's employment and reduce our carbon footprint.



The environment: a priority for us

VESTA technology® is designed with a circular approach and is based on an exceptionally high level of natural wood fibres. Yet, we don't cut down any trees: we recover and recycle virgin and perfectly healthy scrap wood from sustainably managed European forests. Like solid wood, our materials are therefore low-carbon. The VESTA® has been awarded the "bio-sourced product" label by Karibati, an expert in bio-sourced building materials.

Our solutions have the advantage of being naturally maintenance free during their lifetime, which avoids the use of water or chemical treatments that are harmful to the environment (varnishes, insecticides, etc.).

Our products are also 100% recyclable. At the end of their service life, they can be ground down again and reused to manufacture new products that are equivalent or suitable for other uses. The carbon stocks therefore remain sustainable.



Looking for inspiration?

Enter a new dimension with our innovative construction solutions
and explore your Neolife product online.

bimobject®



Bâtiment Sendaï
11 chemin des Anciennes Vignes
69410 Champagne-au-Mont-d'Or

+33 (0)4 78 25 63 08
contact@neolife.fr



neolife.fr/en

